



Tubo di rinforzo centrale (Ø 18 mm)



Borsa per il trasporto

MODULATE SLOPE 2

MOD-SS-824-02

Modulate™ è costituito da una serie di cornici con tubolari in alluminio (Ø 30 mm) e rivestiti da una stampa in tessuto elasticizzato.

Queste strutture possono facilmente connettersi tra loro usando potenti magneti posizionati all'interno di ogni struttura. La gamma Modulate™ è disponibile in 19 diversi formati.

CARATTERISTICHE

Struttura tubolare in alluminio (Ø 30 mm).

Sistema autobloccante con tubolari a sezioni e pulsante a scatto.

Rivestimento con una stampa in tessuto fronte-retro con chiusura a zip.

Sistema di etichettatura numerata intuitiva di ogni sezione per facilitare l'assemblaggio.

2 basi di supporto con sistema Twist & Lock fornite con ogni cornice.

I PLUS

Grazie al sistema magnetico MagLink integrato nella struttura, le cornici possono essere collegate tra loro semplicemente avvicinandole.

Le stampe in tessuto richiedono poca manutenzione essendo ingualcibili e lavabili in lavatrice.

SCHEDA PRODOTTO

SPECIFICHE TECNICHE

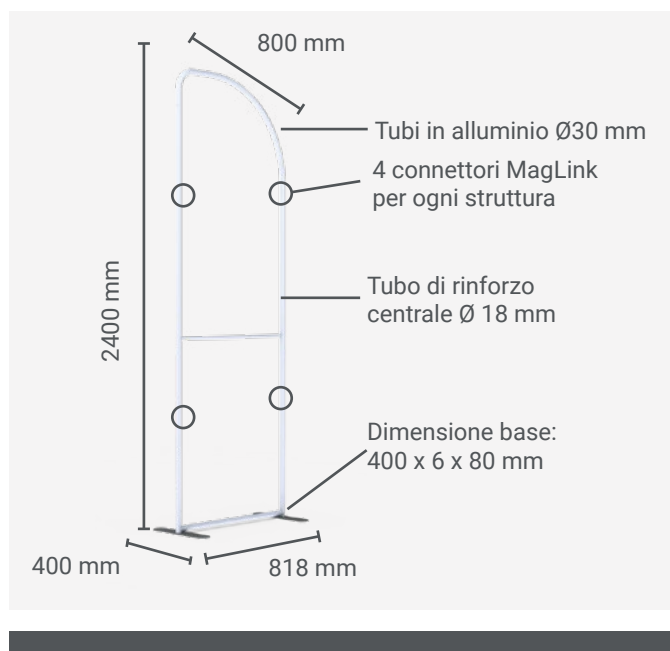

Codice	Descrizione	Dimensioni struttura (mm) - l x h x p	Peso struttura assemblata	Dimensioni del collo (mm) - l x h x p	Peso collo
MOD-SS-824-02	Modulate Slope 2	818 x 2400 x 400	4,9 kg	230 x 1000 x 125	6,9 kg

SCHEDA PRODOTTO

ASSEMBLAGGIO STRUTTURA

1 COMPONENTI



Sezioni tubolari superiori (x1)

Tubo superiore (x1)

Sezioni tubolari inferiori (x2)

Tubo orizzontale inferiore (x1)

Sezioni tubolari verticali (x1)

Tubo di rinforzo centrale (x1)

Basi (x2)

Guanti (x2)

2

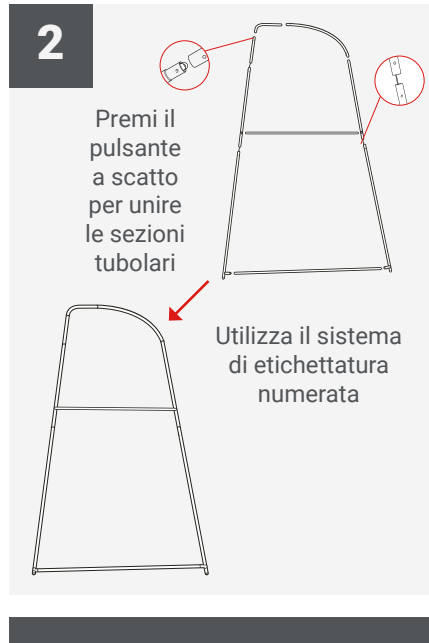

Premi il pulsante a scatto per unire le sezioni tubolari

Utilizza il sistema di etichettatura numerata

3

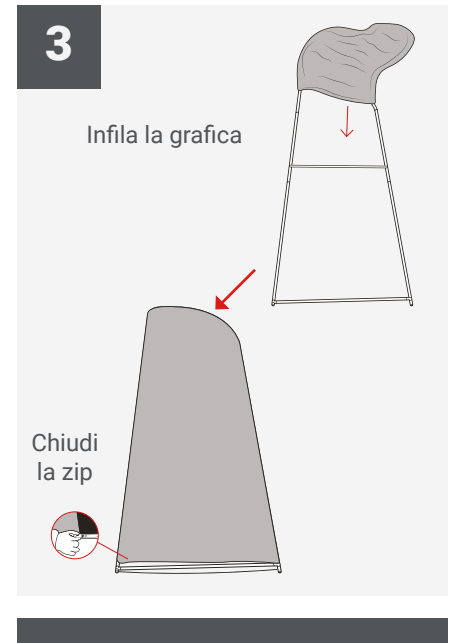

Infila la grafica

Chiudi la zip

4

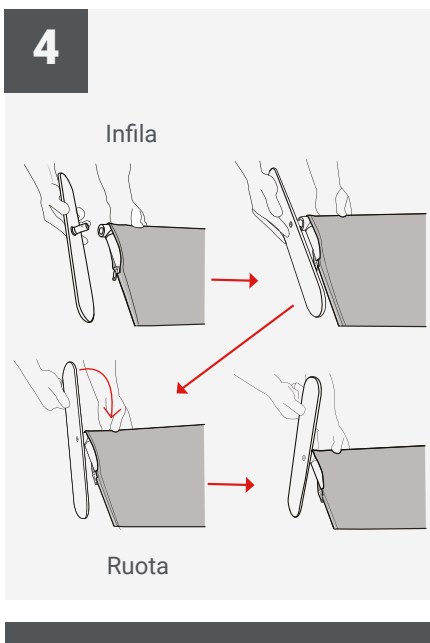

Infila

Ruota

5



L'adesivo sulla base mostra le indicazioni di bloccaggio e sbloccaggio della base stessa

Le basi possono essere posizionate all'interno o all'esterno della struttura



Chiunque abbia un impianto medico deve mantenere una distanza minima di 30 cm.



Rischio di pizzicamento in caso di interazione con oggetti metallici.

UNIRE PIÙ CORNICI

1

Togli una base dalla
seconda cornice e unisci le
cornici utilizzando una
sola base

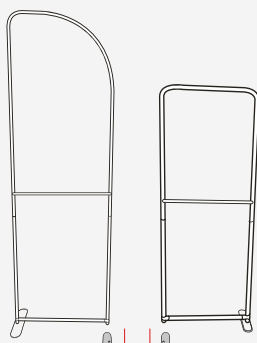

Rimuovi

2

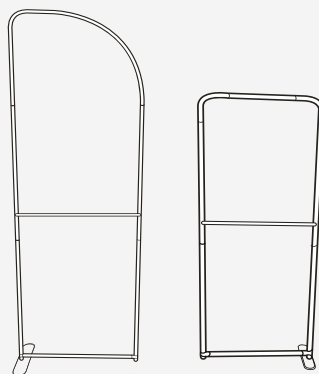

Ruota

3

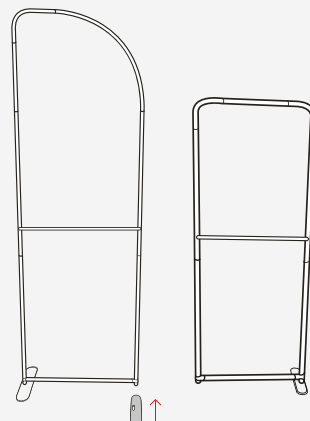

Infila

4

Sistema MagLink
integrato nel tubo

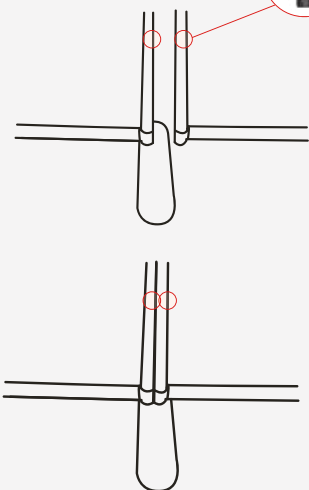

5

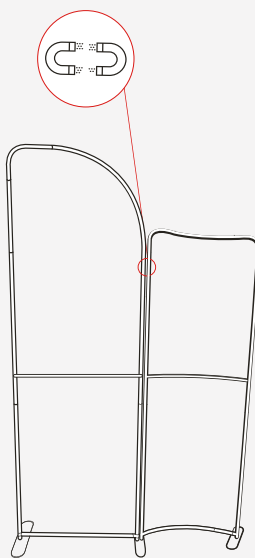

ISTRUZIONI MONTAGGIO

ACCESSORI (SU RICHIESTA)



Mezze basi Modulate (coppia)
MOD-HALF-FOOT-P
218 x 6 x 80 mm



Spot LED Flood
LED-FLOOD-ARM-BDLK



Kit di fissaggio universale
US901-C

MIX & MATCH LA LINEA MODULATE

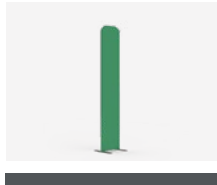

Straight 420
MOD-S-420

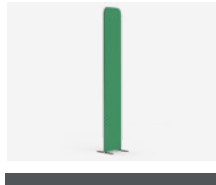

Straight 424
MOD-S-424

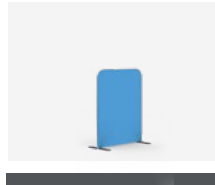

Straight 810
MOD-S-810



Straight 820
MOD-S-820



Straight 824
MOD-S-824

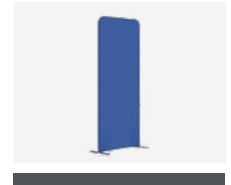

Straight 1020
MOD-S-1020

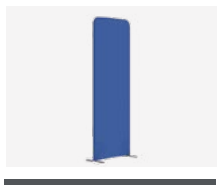

Straight 1024
MOD-S-1024

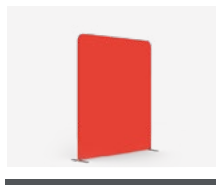

Straight 1820
MOD-S-1820



Straight 1824
MOD-S-1824

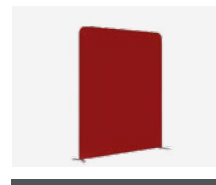

Straight 2020
MOD-S-2020



Straight 2024
MOD-S-2024

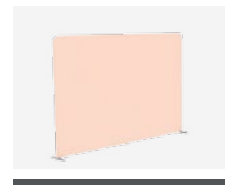

Straight 3020
MOD-S-3020

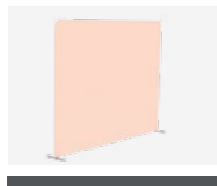

Straight 3024
MOD-S-3024

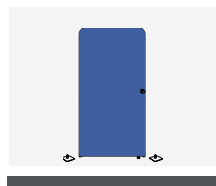

Porta 820
MOD-S-DOOR-820

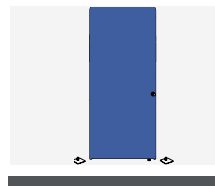

Porta 824
MOD-S-DOOR-824



Curved 820
MOD-C-820

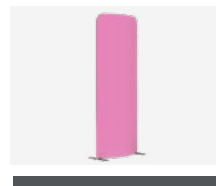

Curved 824
MOD-C-824



Slope 1
MOD-SS-824-01

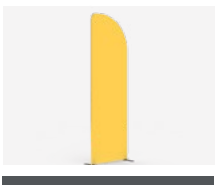

Slope 2
MOD-SS-824-02



DISPONIBILE
ANCHE CON
ANGOLI RETTI

ISTRUZIONI MONTAGGIO